

# 43347

## RTD Temperature Probe and 43502 and 41003-5 Radiation Shields





# Guarantee

---

This equipment is guaranteed against defects in materials and workmanship. We will repair or replace products which prove to be defective during the guarantee period as detailed on your invoice, provided they are returned to us prepaid. The guarantee will not apply to:

- Equipment which has been modified or altered in any way without the written permission of Campbell Scientific
- Batteries
- Any product which has been subjected to misuse, neglect, acts of God or damage in transit.

Campbell Scientific will return guaranteed equipment by surface carrier prepaid. Campbell Scientific will not reimburse the claimant for costs incurred in removing and/or reinstalling equipment. This guarantee and the Company's obligation thereunder is in lieu of all other guarantees, expressed or implied, including those of suitability and fitness for a particular purpose. Campbell Scientific is not liable for consequential damage.

Please inform us before returning equipment and obtain a Repair Reference Number whether the repair is under guarantee or not. Please state the faults as clearly as possible, and if the product is out of the guarantee period it should be accompanied by a purchase order. Quotations for repairs can be given on request. It is the policy of Campbell Scientific to protect the health of its employees and provide a safe working environment, in support of this policy a "Declaration of Hazardous Material and Decontamination" form will be issued for completion.

When returning equipment, the Repair Reference Number must be clearly marked on the outside of the package. Complete the "Declaration of Hazardous Material and Decontamination" form and ensure a completed copy is returned with your goods. Please note your Repair may not be processed if you do not include a copy of this form and Campbell Scientific Ltd reserves the right to return goods at the customers' expense.

Note that goods sent air freight are subject to Customs clearance fees which Campbell Scientific will charge to customers. In many cases, these charges are greater than the cost of the repair.



Campbell Scientific Ltd,  
80 Hathern Road,  
Shepshed, Loughborough, LE12 9GX, UK  
Tel: +44 (0) 1509 601141  
Fax: +44 (0) 1509 270924  
Email: [support@campbellsci.co.uk](mailto:support@campbellsci.co.uk)  
[www.campbellsci.co.uk](http://www.campbellsci.co.uk)



# PLEASE READ FIRST

---

## About this manual

Please note that this manual was originally produced by Campbell Scientific Inc. primarily for the North American market. Some spellings, weights and measures may reflect this origin.

Some useful conversion factors:

<b>Area:</b> 1 in <sup>2</sup> (square inch) = 645 mm <sup>2</sup>	<b>Mass:</b> 1 oz. (ounce) = 28.35 g 1 lb (pound weight) = 0.454 kg
<b>Length:</b> 1 in. (inch) = 25.4 mm 1 ft (foot) = 304.8 mm 1 yard = 0.914 m 1 mile = 1.609 km	<b>Pressure:</b> 1 psi (lb/in <sup>2</sup> ) = 68.95 mb
	<b>Volume:</b> 1 UK pint = 568.3 ml 1 UK gallon = 4.546 litres 1 US gallon = 3.785 litres

In addition, while most of the information in the manual is correct for all countries, certain information is specific to the North American market and so may not be applicable to European users.

Differences include the U.S standard external power supply details where some information (for example the AC transformer input voltage) will not be applicable for British/European use. *Please note, however, that when a power supply adapter is ordered it will be suitable for use in your country.*

Reference to some radio transmitters, digital cell phones and aerials may also not be applicable according to your locality.

Some brackets, shields and enclosure options, including wiring, are not sold as standard items in the European market; in some cases alternatives are offered. Details of the alternatives will be covered in separate manuals.

Part numbers prefixed with a “#” symbol are special order parts for use with non-EU variants or for special installations. Please quote the full part number with the # when ordering.

## Recycling information



At the end of this product's life it should not be put in commercial or domestic refuse but sent for recycling. Any batteries contained within the product or used during the products life should be removed from the product and also be sent to an appropriate recycling facility.

Campbell Scientific Ltd can advise on the recycling of the equipment and in some cases arrange collection and the correct disposal of it, although charges may apply for some items or territories.

For further advice or support, please contact Campbell Scientific Ltd, or your local agent.



Campbell Scientific Ltd, 80 Hathern Road, Shepshed, Loughborough, LE12 9GX,  
UK Tel: +44 (0) 1509 601141 Fax: +44 (0) 1509 270924  
Email: [support@campbellsci.co.uk](mailto:support@campbellsci.co.uk)  
[www.campbellsci.co.uk](http://www.campbellsci.co.uk)



# Safety

---

DANGER — MANY HAZARDS ARE ASSOCIATED WITH INSTALLING, USING, MAINTAINING, AND WORKING ON OR AROUND **TRIPODS, TOWERS, AND ANY ATTACHMENTS TO TRIPODS AND TOWERS SUCH AS SENSORS, CROSSARMS, ENCLOSURES, ANTENNAS, ETC.** FAILURE TO PROPERLY AND COMPLETELY ASSEMBLE, INSTALL, OPERATE, USE, AND MAINTAIN TRIPODS, TOWERS, AND ATTACHMENTS, AND FAILURE TO HEED WARNINGS, INCREASES THE RISK OF DEATH, ACCIDENT, SERIOUS INJURY, PROPERTY DAMAGE, AND PRODUCT FAILURE. TAKE ALL REASONABLE PRECAUTIONS TO AVOID THESE HAZARDS. CHECK WITH YOUR ORGANIZATION'S SAFETY COORDINATOR (OR POLICY) FOR PROCEDURES AND REQUIRED PROTECTIVE EQUIPMENT PRIOR TO PERFORMING ANY WORK.

Use tripods, towers, and attachments to tripods and towers only for purposes for which they are designed. Do not exceed design limits. Be familiar and comply with all instructions provided in product manuals. Manuals are available at [www.campbellsci.eu](http://www.campbellsci.eu) or by telephoning +44(0) 1509 828 888 (UK). You are responsible for conformance with governing codes and regulations, including safety regulations, and the integrity and location of structures or land to which towers, tripods, and any attachments are attached. Installation sites should be evaluated and approved by a qualified engineer. If questions or concerns arise regarding installation, use, or maintenance of tripods, towers, attachments, or electrical connections, consult with a licensed and qualified engineer or electrician.

## General

- Prior to performing site or installation work, obtain required approvals and permits. Comply with all governing structure-height regulations, such as those of the FAA in the USA.
- Use only qualified personnel for installation, use, and maintenance of tripods and towers, and any attachments to tripods and towers. The use of licensed and qualified contractors is highly recommended.
- Read all applicable instructions carefully and understand procedures thoroughly before beginning work.
- Wear a **hardhat** and **eye protection**, and take **other appropriate safety precautions** while working on or around tripods and towers.
- **Do not climb** tripods or towers at any time, and prohibit climbing by other persons. Take reasonable precautions to secure tripod and tower sites from trespassers.
- Use only manufacturer recommended parts, materials, and tools.

## Utility and Electrical

- **You can be killed** or sustain serious bodily injury if the tripod, tower, or attachments you are installing, constructing, using, or maintaining, or a tool, stake, or anchor, come in **contact with overhead or underground utility lines.**
- Maintain a distance of at least one-and-one-half times structure height, or 20 feet, or the distance required by applicable law, **whichever is greater**, between overhead utility lines and the structure (tripod, tower, attachments, or tools).
- Prior to performing site or installation work, inform all utility companies and have all underground utilities marked.
- Comply with all electrical codes. Electrical equipment and related grounding devices should be installed by a licensed and qualified electrician.

## Elevated Work and Weather

- Exercise extreme caution when performing elevated work.
- Use appropriate equipment and safety practices.
- During installation and maintenance, keep tower and tripod sites clear of un-trained or non-essential personnel. Take precautions to prevent elevated tools and objects from dropping.
- Do not perform any work in inclement weather, including wind, rain, snow, lightning, etc.

## Maintenance

- Periodically (at least yearly) check for wear and damage, including corrosion, stress cracks, frayed cables, loose cable clamps, cable tightness, etc. and take necessary corrective actions.
- Periodically (at least yearly) check electrical ground connections.

WHILE EVERY ATTEMPT IS MADE TO EMBODY THE HIGHEST DEGREE OF SAFETY IN ALL CAMPBELL SCIENTIFIC PRODUCTS, THE CUSTOMER ASSUMES ALL RISK FROM ANY INJURY RESULTING FROM IMPROPER INSTALLATION, USE, OR MAINTENANCE OF TRIPODS, TOWERS, OR ATTACHMENTS TO TRIPODS AND TOWERS SUCH AS SENSORS, CROSSARMS, ENCLOSURES, ANTENNAS, ETC.





# Table of Contents

---

PDF viewers: These page numbers refer to the printed version of this document. Use the PDF reader bookmarks tab for links to specific sections.

<b>1. Introduction.....</b>	<b>1</b>
<b>2. Precautions .....</b>	<b>1</b>
<b>3. Initial Inspection .....</b>	<b>1</b>
<b>4. QuickStart .....</b>	<b>1</b>
<b>5. Overview .....</b>	<b>3</b>
<b>6. Specifications .....</b>	<b>4</b>
6.1    43347 Rtd Temperature Probe .....	4
6.2    43502 Aspirated Radiation Shield.....	5
6.3    41003-5 Radiation Shield.....	5
<b>7. Installation .....</b>	<b>6</b>
7.1    Siting .....	6
7.2    Required Tools.....	6
7.3    Radiation Shield Installation .....	6
7.3.1    43502 Radiation Shield Mounting .....	7
7.3.2    41003-5 Radiation Shield Mounting.....	12
7.4    Wiring .....	13
7.4.1    43347 Sensor Wiring .....	13
7.4.1.1    –VX Wiring.....	14
7.4.1.2    –IX Wiring .....	15
7.4.2    43502 Aspirated Radiation Shield Wiring .....	16
7.5    Data Logger Programming.....	17
7.5.1    Program Structure .....	17
7.5.2    BRHalf4W() CRBasic Instruction .....	18
7.5.3    Resistance() CRBasic Instruction.....	18
7.5.4    Calibration Equation .....	18
7.5.5    PRTCalc() CRBasic Instruction .....	19
7.5.6    Pulse() CRBasic Instruction.....	19
<b>8. Operation .....</b>	<b>19</b>
8.1    Resistance Measurement Instruction Details.....	19
8.1.1    Determining the Excitation Current .....	20
8.1.2    Reducing Measurement Noise .....	21
<b>9. Troubleshooting and Maintenance.....</b>	<b>21</b>
9.1    Maintenance .....	21
9.2    Troubleshooting .....	21
9.3    43347 Probe Calibration.....	22

**10. Attributes and References ..... 22**

**Appendices**

**A. Importing Short Cut Code Into CRBasic Editor... A-1**

**B. Example Programs ..... B-1**

B.1 43347-VX Programs .....B-1  
 B.1.1 Example for Calibrated 43347-VX Probes .....B-1  
 B.1.2 Example for Uncalibrated 43347-VX Probes .....B-2  
 B.2 43347-IX Programs.....B-3  
 B.2.1 Example for Calibrated 43347-IX Probe .....B-4  
 B.2.2 Example for Uncalibrated 43347-IX Probe.....B-4

**C. 43502 Aspirated Radiation Shield ..... C-1**

**D. Measure Multiple 43347-IX Probes Using One Current Excitation Terminal..... D-1**

D.1 Wiring ..... D-2  
 D.2 Example Program for Two Calibrated 43347-IX Probes ..... D-3

**Figures**

7-1. 43502 Radiation Shield mounted to tripod mast .....7  
 7-2. 43502 Radiation Shield mounted to a CM200-series Crossarm.....8  
 7-3. 43347 probe and bushing .....9  
 7-4. 43347 probe mounted inside the 43502 shield .....9  
 7-5. 43502 shield terminals .....10  
 7-6. Closeup of terminal box .....11  
 7-7. 41003-5 Radiation Shield mounted to tripod mast.....12  
 7-8. 41003-5 Radiation Shield mounted to a CM200-series Crossarm .....13  
 7-9. 43347-VX Temperature Probe wiring.....14  
 7-10. 43347-IX Temperature Probe schematic.....15  
 7-11. 43502 Aspirated Shield wiring.....16  
 D-1. Schematic for two 43347-IX Temperature Probes ..... D-2

**Tables**

7-1. -VX Option Wire Colour, Function, and Data Logger Connection...14  
 7-2. -IX Option Wire Colour, Function, and Data Logger Connection ....15  
 7-3. 43502 Blower/Tachometer Connections .....16  
 7-4. CRBasic Instructions Used to measure the 43347.....17  
 B-1. Wiring for Calibrated 43347-VX Example .....B-1  
 B-2. Wiring for Uncalibrated 43347-VX Example .....B-2  
 B-3. Wiring for 43347-IX Examples.....B-3  
 D-1. Wiring for Two 43347-IX Probes Example ..... D-3

**CRBasic Examples**

B-1. CR1000X Example for Calibrated 43347-VX Probes .....B-2  
 B-2. CR1000X Example for Uncalibrated 43347-VX Probes .....B-3  
 B-3. CR6 Example for Calibrated 43347-IX Probe .....B-4

B-4. CR6 Example for Uncalibrated 43347-IX Probe .....B-4  
D-1. CR3000 Example for Two Calibrated 43347-IX Probes..... D-3



# 43347 RTD Temperature Probe, 43502 and 41003-5 Radiation Shields

---

## 1. Introduction

The 43347 is a highly-accurate RTD that often provides delta temperature measurements for air quality applications. Typically, it is housed in the 43502 fan-aspirated radiation shield, which greatly reduces radiation errors. It may also be used with the 41003-5 10-plate naturally-aspirated radiation shield.

### NOTE

---

This manual provides information only for CRBasic data loggers. For retired Edlog data logger support, see an older manual at [www.campbellsci.com/old-manuals](http://www.campbellsci.com/old-manuals). Also, see an older manual if using the retired 43408 radiation shield.

---

## 2. Precautions

- READ AND UNDERSTAND the *Safety* section at the front of this manual.
- Care should be taken when opening the shipping package to not damage or cut the cable jacket. If damage to the cable is suspected, contact Campbell Scientific.
- Although the 43347 and 43502 are rugged, they should be handled as a precision scientific instrument.
- The black outer jacket of the cable is Santoprene® rubber. This compound was chosen for its resistance to temperature extremes, moisture, and UV degradation. However, this jacket will support combustion in air. It is rated as slow burning when tested according to U.L. 94 H.B. and will pass FMVSS302. Local fire codes may preclude its use inside buildings.

## 3. Initial Inspection

- Upon receipt of the 43347 and 43502, inspect the packaging and contents for damage. File damage claims with the shipping company.
- Immediately check package contents against the shipping documentation. Contact Campbell Scientific about any discrepancies.

## 4. QuickStart

A video that describes data logger programming using Short Cut is available at: [www.campbellsci.eu/videos/cr1000x-datalogger-getting-started-program-part-3](http://www.campbellsci.eu/videos/cr1000x-datalogger-getting-started-program-part-3). *Short Cut* is an easy way to program your data logger to measure the sensor and assign data logger wiring terminals. Short Cut is available as a download on [www.campbellsci.eu](http://www.campbellsci.eu). It is included in installations of LoggerNet, PC200W, PC400, or RTDAQ.

The following procedure also shows using Short Cut to program the RTD.

1. Open Short Cut and click **Create New Program**.
2. Double-click the data logger model.
3. In the **Available Sensors and Devices** box, type 43347 or find the sensor in the **Sensors > Temperature** folder. Double-click **43347-VX RTD Temperature Probe**. Data defaults to degrees Celsius. This can be changed by clicking the **Deg C** box and selecting **Deg F**, for degrees Fahrenheit, or **K** for Kelvin. If the 43347 is calibrated, ensure that the **Calibrated** box is checked and type the **C0**, **C1**, and **C2** values provided in the calibration certificate that was shipped with the sensor. These values are unique for each sensor.

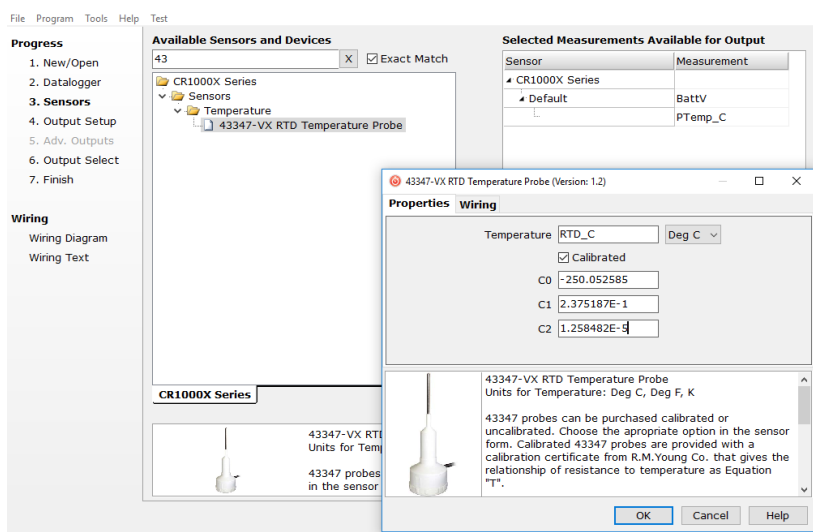

4. Click the **Wiring** tab. Click **OK** after wiring the sensor.

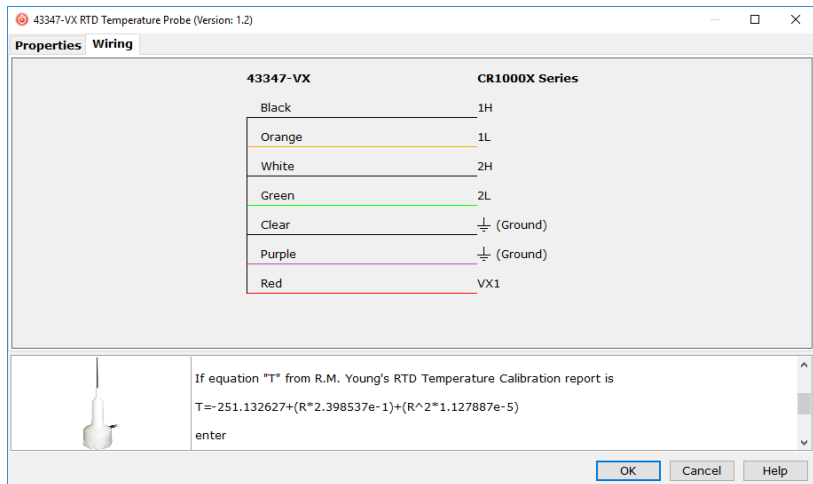

5. Repeat steps three and four for other sensors you want to measure. Click **Next**.

- In **Output Setup**, type the scan rate, a meaningful **Table Name**, and the **Data Output Storage Interval**. Click **Next**.

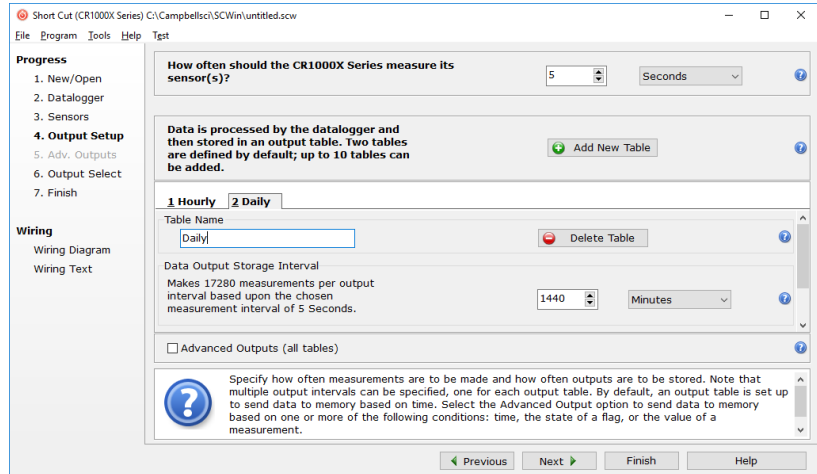

- Select the output options.

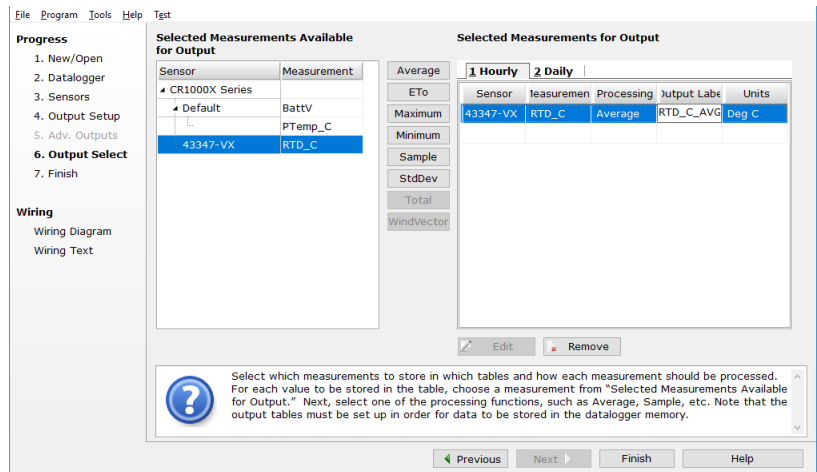

- Click **Finish** and save the program. Send the program to the data logger if the data logger is connected to the computer.
- If the sensor is connected to the data logger, check the output of the sensor in the data display in LoggerNet, PC400, RTDAQ, or PC200W to make sure it is making reasonable measurements.

## 5. Overview

The 43347 is a 1000 Ω resistance temperature device (RTD) used to measure ambient air temperature and delta or gradient air temperature. The standard 43347 probe has an uncertainty of ±0.3 °C. For increased accuracy, the 43347 probe can be ordered with a three point calibration with an uncertainty of ±0.1 °C.

There are two cable options for the 43347. Option –VX configures the probe as a 4-wire half bridge that requires a voltage excitation and two differential input terminals, and can be used with all Campbell Scientific data loggers except the

CR300 series and CR200(X) series. Option –IX configures the probe for use with the CR6, CR3000, or CR5000 data loggers, and requires a current excitation and one differential input terminal.

The 43347 is typically housed in the 43502 motor aspirated radiation shield, but can also be housed in the 41003-5 naturally aspirated radiation shield. The 43502 radiation shield employs concentric downward facing intake tubes and a small canopy shade to isolate the temperature probe from direct and indirect radiation. The 43347 probe mounts vertically in the centre of the intake tubes. A brushless 12 VDC blower motor pulls ambient air into the shield and across the probe to reduce radiation errors.

The 43502 blower operates off a 115 VAC/12 VDC transformer that is included with the shield, or from a user-provided 12 VDC source. The blower has a Tachometer output that is measured with a control port or pulse counter input on the data logger, and the output frequency stored as part of the data to insure the blower was operational.

Cable length for the 43347 and 43502 is specified when the probe/shield is ordered. Maximum cable length for the 43502 is 22.8 m (75 ft), which is based upon 22 AWG wire, 500 mA current draw, and an allowance for a 1 V voltage drop across the cable. Larger diameter wire could be used for longer cable lengths. With 18 AWG wire, the maximum length is 60.9 m (200 ft).

## 6. Specifications

### Features:

- Uses 1000  $\Omega$  PRT for highly accurate air temperature measurements
- Well-suited for air quality applications
- 43502 fan-aspirated radiation shield reduces radiation errors for more accurate measurements
- Ideal for delta temperature measurements used in calculating atmospheric stability class
- Compatible with Campbell Scientific CRBasic data loggers: CR6, CR800 series, CR1000X, CR1000, CR3000, CR5000, and CR9000(X)

### 6.1 43347 Rtd Temperature Probe

**RM Young**

**Model Number:** 41342

#### Probe Tip

**Stainless Steel**

**Sheath Diameter:** 0.478 cm (0.188 in)

**Stainless Steel**

**Sheath Length:** 6.12 cm (2.41 in)

**Total Probe Tip**

**Length (stainless**

**steel sheath and**

**moulded plastic):** 10.08 cm (3.97 in)

**Overall Length:** 17.8 cm (7 in)



<b>Sensing Element:</b>	HY-CAL 1000 $\Omega$ Platinum RTD
<b>Temperature Range:</b>	$\pm 50$ $^{\circ}\text{C}$
<b>Accuracy:</b>	$\pm 0.3$ $^{\circ}\text{C}$ at 0 $^{\circ}\text{C}$ $\pm 0.1$ $^{\circ}\text{C}$ with NIST calibration
<b>Temperature Coefficient:</b>	0.00375 $\Omega/\Omega$ $^{\circ}\text{C}$

## 6.2 43502 Aspirated Radiation Shield

<b>Sensor Types:</b>	Accommodates sensors up to 24 mm (0.9 in) diameter
<b>Radiation Error Ambient Temperature Delta T:</b>	<0.2 $^{\circ}\text{C}$ (0.4 $^{\circ}\text{F}$ ) RMS (@1000 $\text{W}/\text{m}^2$ intensity) <0.05 $^{\circ}\text{C}$ (0.1 $^{\circ}\text{F}$ ) RMS with like shields equally exposed
<b>Aspiration Rate:</b>	5 to 11 m/s (16 to 36 fps) depending on sensor size
<b>Power Requirement:</b>	12 to 14 VDC @ 500 mA for blower
<b>Tachometer Output:</b>	0 to 5 VDC square wave pulse, 2 pulses per revolution Approximately 146 Hz (4380 rpm) @ 12 VDC
<b>Overall</b>	
<b>Height:</b>	33 cm (13 in)
<b>Diameter:</b>	20 cm (8 in)
<b>Shield</b>	
<b>Diameter:</b>	7 cm (2.7 in)
<b>Length:</b>	12 cm (4.7 in)
<b>Blower Housing</b>	
<b>Diameter:</b>	17 cm (6.7 in)
<b>Length:</b>	11 cm (4.3 in)
<b>Mounting:</b>	V-block and U-bolt fits vertical pipe with 25 to 50 mm (1.0 to 2.0 in) outer diameter

## 6.3 41003-5 Radiation Shield

<b>Sensor Types:</b>	Accommodates temperature and humidity sensors up to 26 mm (1 in) diameter
<b>Radiation Error:</b>	@1080 $\text{W}/\text{m}^2$ intensity – Dependent on wind speed 0.4 $^{\circ}\text{C}$ (0.7 $^{\circ}\text{F}$ ) RMS @ 3 m/s (6.7 mph) 0.7 $^{\circ}\text{C}$ (1.3 $^{\circ}\text{F}$ ) RMS @ 2 m/s (4.5 mph) 1.5 $^{\circ}\text{C}$ (2.7 $^{\circ}\text{F}$ ) RMS @ 1 m/s (2.2 mph)

<b>Construction:</b>	UV stabilized white thermoplastic plates Aluminium mounting bracket, white powder coated Stainless steel U-bolt clamp
<b>Diameter:</b>	13 cm (5.1 in)
<b>Height:</b>	26 cm (10.2 in)
<b>Mounting:</b>	Fits vertical pipe with 25 to 50 mm (1 to 2 in) outer diameter
<b>Weight</b>	
<b>Net Weight:</b>	0.7 kg (1.5 lb)
<b>Shipping Weight:</b>	1.4 kg (3 lb)

## 7. Installation

If you are programming your data logger with *Short Cut*, skip Section 7.4.1, *43347 Sensor Wiring* (p. 13), and Section 7.5, *Data Logger Programming* (p. 17). *Short Cut* does this work for you. See Section 4, *QuickStart* (p. 1), for a *Short Cut* tutorial.

### 7.1 Siting

Sensors should be located over an open level area at least 9 m (EPA) in diameter. The surface should be covered by short grass, or where grass does not grow, the natural earth surface. Sensors should be located at a distance of at least four times the height of any nearby obstruction, and at least 30 m (EPA) from large paved areas. Sensors should be protected from thermal radiation, and adequately ventilated.

Standard measurement heights:

- 1.5 m ±1.0 m (AASC)
- 1.25 to 2.0 m (WMO)
- 2.0 m (EPA)
- 2.0 m and 10.0 m temperature difference (EPA)

### 7.2 Required Tools

- 1/2-inch open-end wrench
- small screw driver provided with data logger
- small Phillips screw driver
- UV resistant cable ties
- small pair of diagonal-cutting pliers

### 7.3 Radiation Shield Installation

The 43347 is typically housed in the 43502 motor aspirated radiation shield, but can also be housed in the 41003-5 naturally aspirated radiation shield. These radiation shields are configured for attaching the shield to a vertical tripod mast or tower leg. By moving the U-bolt to the other set of holes the radiation shields can be attached to a CM200-series crossarm. The crossarm includes a CM210 Mounting Kit for attaching the crossarm to a tripod mast or tower leg. For triangular towers such as the UT30, an additional CM210

Crossarm Mounting Kit can be ordered for attaching the crossarm to two tower legs, increasing the stability.

### 7.3.1 43502 Radiation Shield Mounting

Appendix C, *43502 Aspirated Radiation Shield (p. C-1)*, provides names and locations of shield components and position of sensor within the shield.

1. Loosen the captive screw in the blower cover (see FIGURE 7-1).



FIGURE 7-1. 43502 Radiation Shield mounted to tripod mast

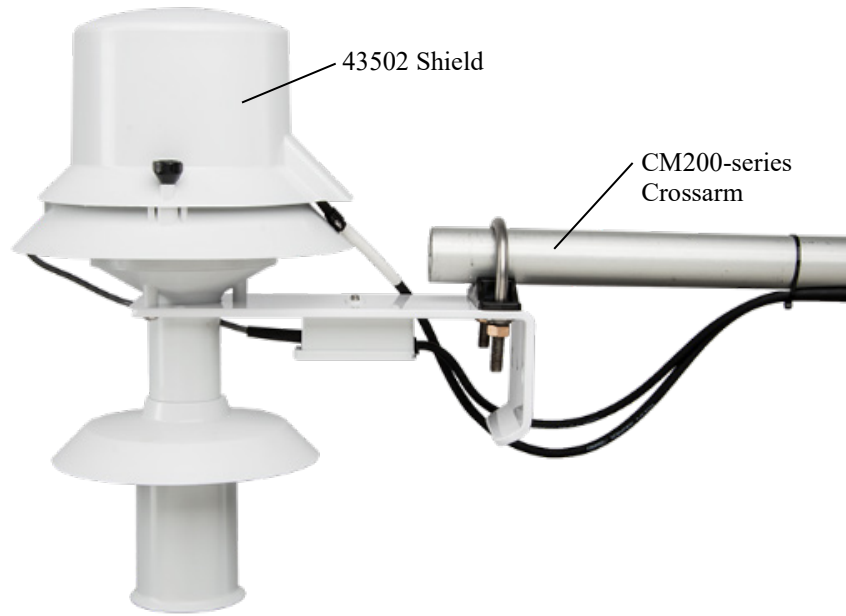

*FIGURE 7-2. 43502 Radiation Shield mounted to a CM200-series Crossarm*

2. Open the blower cover, which is hinged to allow easy access for sensor installation and cable connections.
3. Insert the 43347 probe inside the 43502 shield using the sensor mounting bushing (supplied with the 43502) as shown in FIGURE 7-3.
4. Route the sensor cable through the notch in the blower housing. The black grommet provides a seal (FIGURE 7-3 and FIGURE 7-4).
5. Clamp the sensor cable using the sensor cable clamp to keep it in proper position when the cover is closed (FIGURE 7-4).

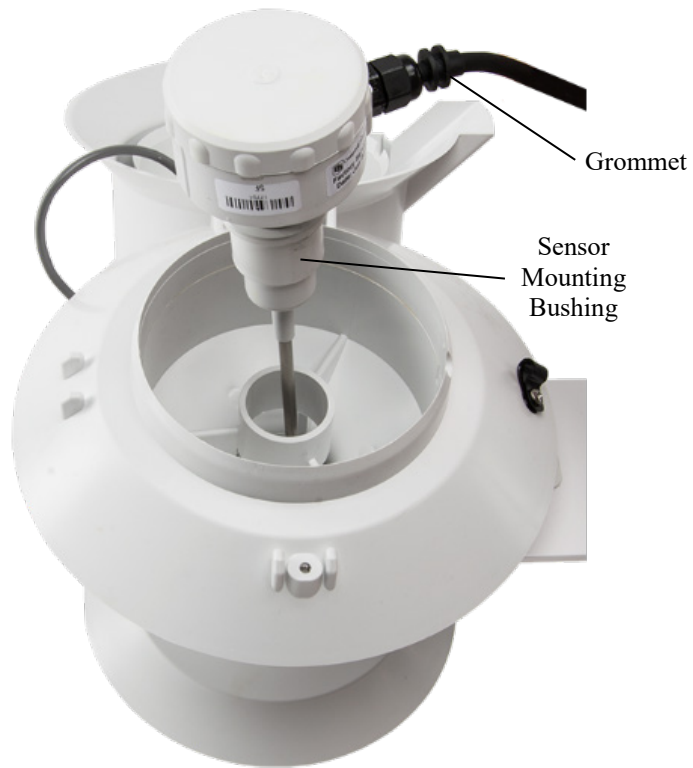

FIGURE 7-3. 43347 probe and bushing



FIGURE 7-4. 43347 probe mounted inside the 43502 shield

6. Turn the sensor over to access the fan power terminal box. Remove the screw holding the lid in place and slide the lid towards the shield as shown in FIGURE 7-5.



FIGURE 7-5. 43502 shield terminals

7. Remove the grommet from the edge of the box and slide it over the power cable. Push it down around 8 to 10 cm (3 to 4 in) past the end of the outer jacket.
8. Remove the screw holding the cable clamp in place and slide the clamp over the cable just past the end of the outer jacket.
9. The terminal blocks are labelled on the printed circuit board. Connect the wires as follows.

Terminal Block Lettering	Wire Colour
TACH	White
POS	Red
NEG	Black

10. Gently bend the wires and cable and screw down the cable clamp as shown in FIGURE 7-6.

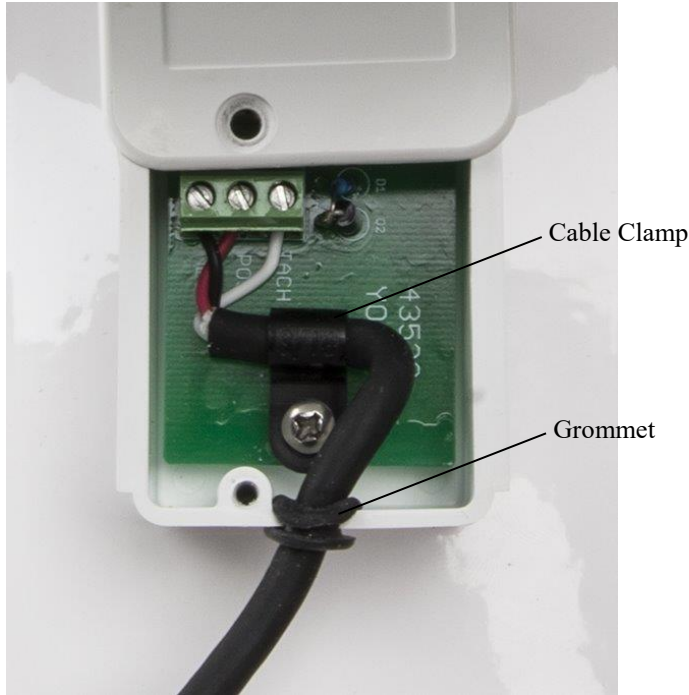

FIGURE 7-6. Closeup of terminal box

11. Slide the grommet into place and push it down into the mating notch on the edge of the box. Slide the lid back into place. Screw the lid back into place. The lid will squeeze down on the grommet.

---

**CAUTION** Be sure to observe correct polarity. Red is positive; black is negative.

---

---

**CAUTION** The blower motor draws approximately 420 mA to 480 mA. Use sufficiently heavy gauge wire between the power supply adapter and the blower motor terminals to avoid significant voltage drop.

---

12. Clamp the blower power cable with the power cable clamp provided at the edge of the printed circuit card (FIGURE 7-6).
13. Plug the AC adapter into the junction box or AC outlet, and use cable ties to secure the power cable to the mounting structure.

---

**CAUTION** Ensure that there is a sufficient loop in the power cable to allow the blower cover to be opened and closed easily.

---

14. Route the sensor cable to the instrument enclosure and secure the cable to the tripod/tower using cable ties.
15. Close the blower cover and tighten the captive screw.

### 7.3.2 41003-5 Radiation Shield Mounting

1. Attach the 41003-5 to the tripod/tower or crossarm using its U-bolt. Tighten the nuts on the U-bolt sufficiently for a secure hold (see FIGURE 7-7 and FIGURE 7-8).
2. Loosen the Hex plug for the 43347 on the bottom plate of the 41003-5, and insert the 43347 into the shield. Tighten the split-nut to secure the sensor in the shield.
3. Route the sensor cable to the instrument enclosure. Secure the cable to the tripod/tower using cable ties.



FIGURE 7-7. 41003-5 Radiation Shield mounted to tripod mast



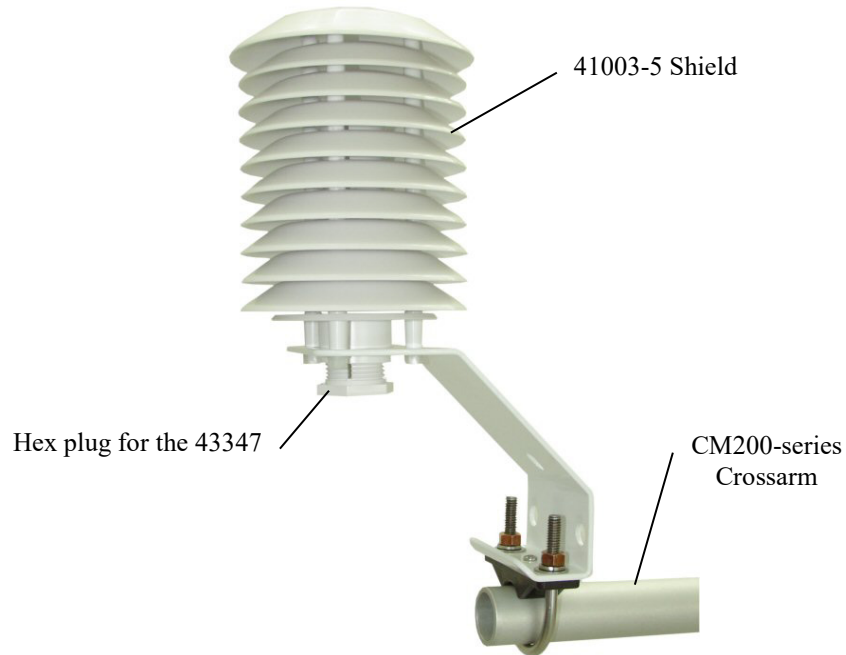

FIGURE 7-8. 41003-5 Radiation Shield mounted to a CM200-series Crossarm

## 7.4 Wiring

To wire an Edlog data logger, see an older manual at [www.campbellsci.com/old-manuals](http://www.campbellsci.com/old-manuals), or contact Campbell Scientific for assistance.

### 7.4.1 43347 Sensor Wiring

The 43347 two wiring configuration options—the VX option and the IX version. The VX option can connect directly to most of our data loggers using a voltage excitation terminal. The IX option can directly connect to data loggers that have a current excitation terminal (CR6, CR3000, CR5000).

43347 probes with the -VX option are wired to the data logger as described in Section 7.4.1.1, *-VX Wiring* (p. 14). 43347 probes with the -IX option are wired to the CR6, CR3000 or CR5000 data loggers as described in Section 7.4.1.2, *-IX Wiring* (p. 15).

---

#### NOTE

Occasionally, a customer may need to connect an IX version of the sensor to a data logger that has voltage excitation only (for example, CR800, CR1000X). The customer can do this by using a 4WPB1K terminal input module (refer to the 4WPB1K manual for more information).

---

7.4.1.1 –VX Wiring

The 43347-VX probe is configured as a four wire half bridge as shown in FIGURE 7-9. Each probe requires two differential inputs and one voltage excitation terminal (one excitation terminal can be used for two probes). The black and orange wires connect to the first of two contiguous input terminals. For example, if terminals 1 and 2 are used, the black and orange wires connect to 1H and 1L respectively, and the white and green wires connect to 2H and 2L respectively.

Connections to Campbell Scientific data loggers are given in TABLE 7-1. When *Short Cut* software is used to create the data logger program, wire the sensor to the terminals shown on the wiring diagram created by *Short Cut*.

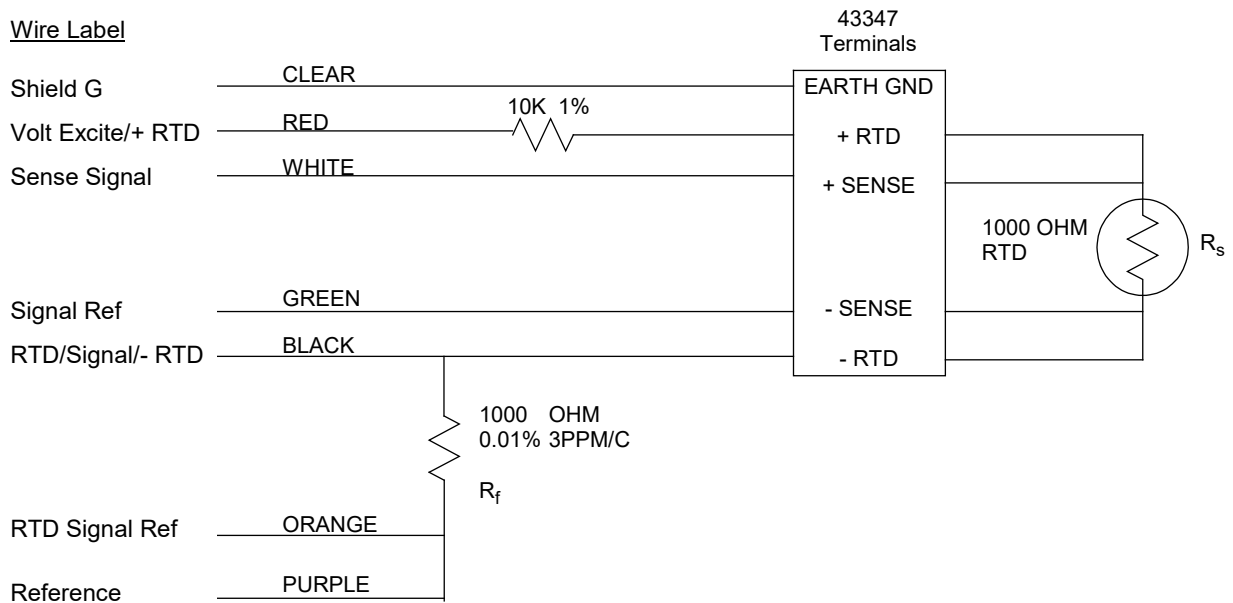

FIGURE 7-9. 43347-VX Temperature Probe wiring

TABLE 7-1. –VX Option Wire Colour, Function, and Data Logger Connection		
Colour	Wire Function	Data Logger Connection
Red	Volt Excite/ + RTD	U configured for voltage excitation <sup>1</sup> , <b>EX</b> , or <b>VX</b> (voltage excitation)
White	Sense Signal	U configured for differential high analogue input <sup>1</sup> , <b>DIFF H</b> (differential high, analogue-voltage input)
Green	Sense Signal Ref	U configured for differential high analogue input <sup>1</sup> , <b>DIFF H</b> (differential high, analogue-voltage input)
Black	RTD Signal/ – RTD	U configured for differential low analogue input <sup>1</sup> , <b>DIFF L</b> (differential low, analogue-voltage input)
Orange	RTD Signal Ref	U configured for differential low analogue input <sup>1</sup> , <b>DIFF L</b> (differential low, analogue-voltage input)

TABLE 7-1. -VX Option Wire Colour, Function, and Data Logger Connection		
Colour	Wire Function	Data Logger Connection
Purple	Excitation Reference	⏏ (analogue ground)
Clear	Shield G	⏏ (analogue ground)

<sup>1</sup>U terminals are automatically configured by the measurement instruction.

### 7.4.1.2 -IX Wiring

The 43347-IX probe is configured as shown in FIGURE 7-10. Connections to the data loggers are shown in TABLE 7-2.

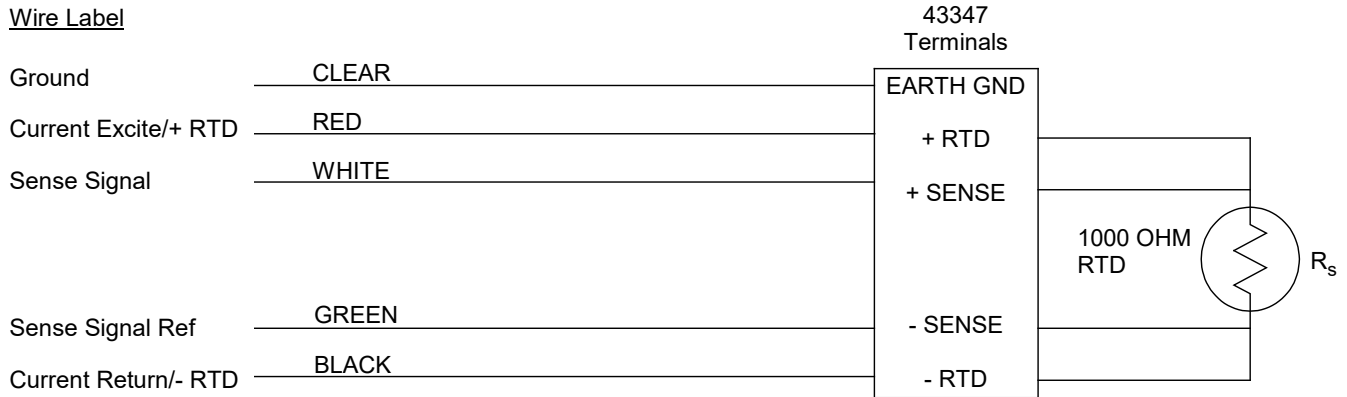

FIGURE 7-10. 43347-IX Temperature Probe schematic

TABLE 7-2. -IX Option Wire Colour, Function, and Data Logger Connection		
Colour	Wire Label	Data Logger Connection
Red	Current Excite/ + RTD	U configured for switched-current excitation <sup>1</sup> , <b>IX</b>
White	Sense Signal	U configured for differential high analogue input <sup>1</sup> , <b>DIFF H</b> (differential high, analogue-voltage input)
Green	Sense Signal Ref	U configured for differential low analogue input <sup>1</sup> , <b>DIFF L</b> (differential low, analogue-voltage input)
Black	Current Return/ - RTD	<b>IXR</b> , ⏏
Clear	Ground	⏏ (analogue ground)

<sup>1</sup>U terminals are automatically configured by the measurement instruction.

### 7.4.2 43502 Aspirated Radiation Shield Wiring

The shield includes a 115 VAC/12 VDC transformer. In most applications AC power is run to the tower or tripod and terminated in a junction box that is large enough to house the transformer(s) as shown in FIGURE 7-11.

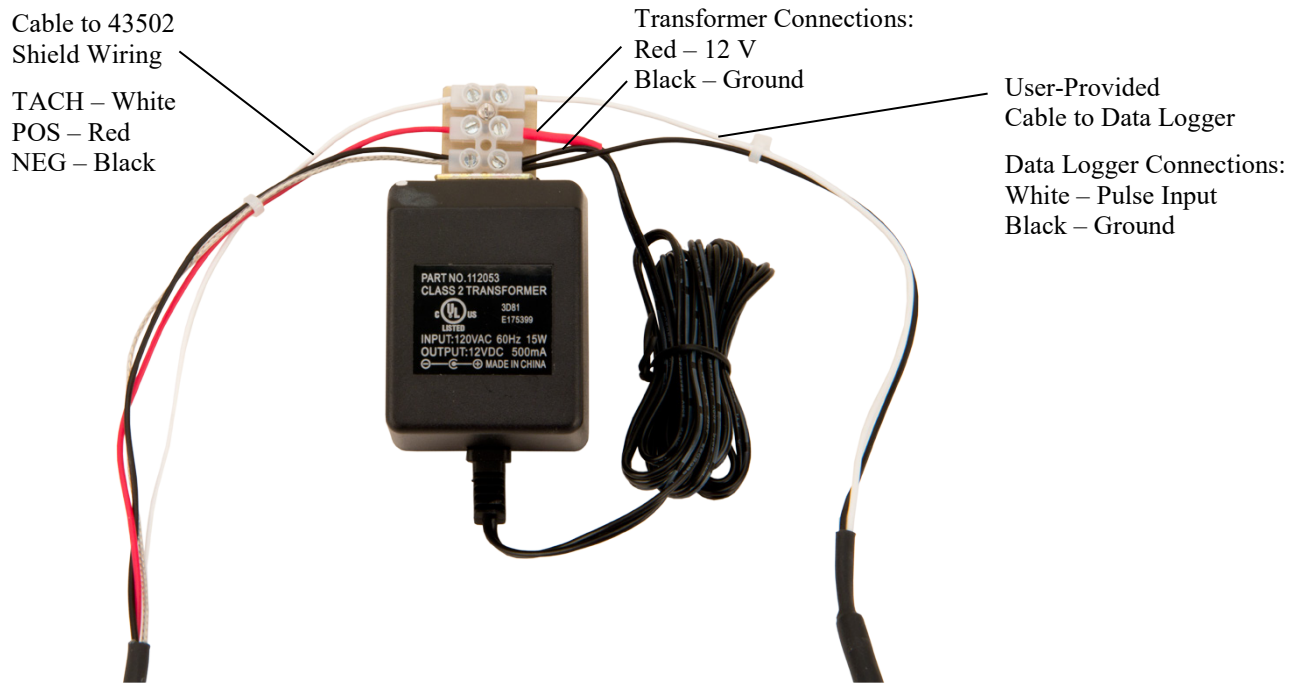

FIGURE 7-11. 43502 Aspirated Shield wiring

Colour	43502	115 VAC/12 VDC Transformer	Data Logger <sup>1</sup>
Red	POS	Terminal/wire with red heat shrink	
Black	NEG	Terminal/wire without heat shrink	<b>G</b>
White	TACH	Spare terminal	<b>U</b> configured for pulse input <sup>2</sup> , <b>P</b> (pulse input), <b>C</b> (control port)
Clear	N/A	Terminal/wire without heat shrink	$\perp$ (analogue ground)

<sup>1</sup>Using Campbell Scientific CABLE2CBL-L or user-provided 2-conductor shielded cable  
<sup>2</sup>U terminals are automatically configured by the measurement instruction.

## 7.5 Data Logger Programming

*Short Cut* can be used to program a 43347 with the –VX option but not the –IX option. *Short Cut* is the best source for up-to-date data logger programming code.

If your data acquisition requirements are simple, you can probably create and maintain a data logger program exclusively with *Short Cut*. If your data acquisition needs are more complex, the files that *Short Cut* creates are a great source for programming code to start a new program or add to an existing custom program.

### NOTE

*Short Cut* cannot edit programs after they are imported and edited in *CRBasic Editor*.

A *Short Cut* tutorial is available in Section 4, *QuickStart* (p. 1). If you wish to import *Short Cut* code into *CRBasic Editor* to create or add to a customized program, follow the procedure in Appendix A, *Importing Short Cut Code Into CRBasic Editor* (p. A-1).

Programming basics for CRBasic data loggers are provided in the following sections. Complete program examples for select data loggers can be found in Appendix B, *Example Programs* (p. B-1).

### 7.5.1 Program Structure

TABLE 7-4 shows the instructions used a 43347 CRBasic program.

Function	Calibrated 43347-VX	Uncalibrated 43347-VX	Calibrated 43347-IX	Uncalibrated 43347-IX
Measure Sensor	<b>BRHalf4W</b> (Section 7.5.2, <i>BRHalf4W()</i> CRBasic Instruction (p. 18))		<b>Resistance</b> (see Section 7.5.3, <i>Resistance()</i> CRBasic Instruction (p. 18))	
Convert to temperature	Mathematical expression (Section 7.5.4, <i>Calibration Equation</i> (p. 18))	<b>PRT</b> (Section 7.5.5, <i>PRTCalc()</i> CRBasic Instruction (p. 19))	Mathematical expression (Section 7.5.4, <i>Calibration Equation</i> (p. 18))	<b>PRT</b> (Section 7.5.5, <i>PRTCalc()</i> CRBasic Instruction (p. 19))
43502 TACH (optional)	<b>PulseCount</b> (Section 7.5.6, <i>Pulse()</i> CRBasic Instruction (p. 19))			

## 7.5.2 BRHalf4W() CRBasic Instruction

The `-VX` option specifies that the probe/cable is configured for a 4-wire half bridge measurement using an excitation voltage. With this configuration, the **BRHalf4W()** CRBasic instruction is used to measure the sensor. The measurement applies an excitation voltage and makes two differential voltage measurements. The first measurement is made across the fixed resistor ( $R_f$ ), the second is made across the RTD ( $R_s$ ). The result is the ratio of the two resistances ( $R_s/R_f$ ), which is not affected by cable length.

The result needs to be converted to temperature. The method used to do this depends on whether the probe is calibrated or uncalibrated. For calibrated probes, see Section 7.5.4, *Calibration Equation* (p. 18). For uncalibrated probes, see Section 7.5.5, *PRTCalc() CRBasic Instruction* (p. 19).

The **BRHalf4W()** instruction has the following form:

```
BrHalf4W(Dest, Repts, Range1, Range2, DiffChan, ExChan, MeasPEX,
          ExmV, RevEx, RevDiff, SettlingTime, Integ, Mult, Offset)
```

Variations:

- Set *Mult* to 1000 if measuring a calibrated sensor.
- Set *Mult* to 1.0 if measuring an uncalibrated sensor

## 7.5.3 Resistance() CRBasic Instruction

CRBasic data loggers compatible with the `-IX` option are the CR6, CR3000, and CR5000. The 43347-IX is measured with the **Resistance()** instruction. This CRBasic instruction applies a switched current excitation and measures the voltage across the 1000  $\Omega$  RTD. The *result*, with a *multiplier* of 1 and an *offset* of 0, is the RTD resistance in ohms.

The result needs to be converted from ohms to temperature. The method used to do this depends on whether the probe is calibrated or uncalibrated. For calibrated probes, see Section 7.5.4, *Calibration Equation* (p. 18). For uncalibrated probes, see Section 7.5.5, *PRTCalc() CRBasic Instruction* (p. 19).

The following is the **Resistance()** instruction with its parameters:

```
Resistance(Dest, Repts, Range, DiffChan, IexChan, MeasPEX, EXuA,
           RevEx, RevDiff, SettlingTime, Integ, Mult, Offset)
```

Details on determining the excitation current and other parameter options are described in Section 8.1, *Resistance Measurement Instruction Details* (p. 19).

## 7.5.4 Calibration Equation

For calibrated 43347 probes, a mathematical equation is used to convert the result to temperature. The mathematical equation is provided with the R.M. Young Co. calibration certificate included with each calibrated probe. This certificate gives the relationship of resistance to temperature ( $^{\circ}\text{C}$ ). The equation will be in the form of:

$$T = C_0 + R \times C_1 + R^2 \times C_2$$

T is the temperature in degrees Celsius.

The values for C<sub>0</sub>, C<sub>1</sub>, and C<sub>2</sub> are unique for each sensor.

When using the **BRHalf4W()** instruction, R is the measured result if *Mult* is set to 1000 and *Offset* is set to 0.0. When using the **Resistance()** instruction, R is the measured result if *Mult* is set to 1.0 and *Offset* is set to 0.0.

### 7.5.5 PRTCalc() CRBasic Instruction

For uncalibrated probes, the **PRTCalc()** instruction is used to convert the ratio R<sub>s</sub>/R<sub>o</sub> to temperature, where R<sub>s</sub> is the measured resistance of the RTD, and R<sub>o</sub> is the resistance of the RTD at 0 degrees Celsius (1000 Ω).

The following is the **PRTCalc()** instruction with its parameters:

**PRTCalc**(Dest, Reps, Source, Type, Mult, Offset)

Select 5 for the *type*, 1.0 for the *multiplier*, and 0.0 for the *offset*.

The **PRT()** instruction can also be used to convert R<sub>s</sub>/R<sub>o</sub> to temperature. More information about the **PRT()** instruction is available at [www.campbellsci.com/old-manuals](http://www.campbellsci.com/old-manuals).

### 7.5.6 Pulse() CRBasic Instruction

The **Pulse()** CRBasic instruction can be used to measure and store the tachometer output frequency (Hz) of the 43502 aspirated radiation shield. Storing the output frequency is a way to insure the blower is operational.

The following is the **PulseCount()** instruction with its parameters:

**PulseCount**(Dest, Reps, PChan, PConfig, POption, Mult, Offset)

For the *PConfig* parameter, use high frequency or high-frequency with pull up.  
For the *POption* parameter, use frequency in Hertz.

See Appendix B, *Example Programs (p. B-1)*, for more information.

## 8. Operation

### 8.1 Resistance Measurement Instruction Details

The **Resistance()** instruction applies a switched current excitation to the 43347 probe, and makes two differential voltage measurements. The first differential voltage measurement is made across the RTD; the second is made across a precision 1000 Ω resistor in the data logger current excitation circuitry. The measurement result (X) = V<sub>s</sub>/I<sub>x</sub> = RTD resistance in ohms, where V<sub>s</sub> is the measured voltage and I<sub>x</sub> is the excitation current.

The maximum excitation current is ±2.5 mA. The parameters for the excitation current, measurement range, differential terminals, and options to reverse the excitation current and switch the differential inputs are configurable, as discussed in the following sections.

When relatively large resistances are measured ( $> 1000$  ohms), or relatively long cable lengths are used ( $> 50$  feet) with sensors requiring current excitation, a  $0.1 \mu\text{f}$  capacitor should be placed between the IX and IXR to prevent excessive ringing. The capacitor serves a feed-forward function. With this capacitor present, a minimum of 3 ms is recommended for the *Settling Time* parameter in the measurement instruction. The capacitor simply connects between the IX terminal and the IXR terminal. The capacitor has no polarity. Campbell Scientific offers a  $0.1 \mu\text{f}$  capacitor.

### 8.1.1 Determining the Excitation Current

Current passing through the RTD causes heating within the RTD (referred to as self-heating) resulting in a measurement error. To minimize self-heating errors, use the minimum current that will still give the desired resolution. The best resolution is obtained when the excitation is large enough to cause the signal voltage to fill the measurement range.

The following example determines an excitation current that keeps self-heating effects below  $0.002 \text{ }^\circ\text{C}$  in still air.

Self heating can be expressed as

$$\Delta T = (I_X^2 R_{\text{RTD}}) \theta$$

Where:  $\Delta T$  = self-heating in  $^\circ\text{C}$

$I_X$  = current excitation

$R_{\text{RTD}}$  =  $1000 \Omega$  RTD resistance

$\theta$  =  $0.05^\circ\text{C}/\text{mW}$  self-heating coefficient

Solving the preceding equation for  $I_X$ :

$$I_X = (\Delta T / R_{\text{RTD}} \theta)^{1/2}$$

To keep self-heating errors below  $0.002 \text{ }^\circ\text{C}$ , the maximum current  $I_X$  is:

$$I_X = (0.002 \text{ }^\circ\text{C} / (1000 \Omega \times 0.05 \text{ }^\circ\text{C} / 0.001\text{W}))^{1/2}$$

$$I_X = 200 \mu\text{A}$$

The best resolution is obtained when the excitation is large enough to cause the signal voltage to fill the measurement full scale range (the possible ranges are  $\pm 5000$ ,  $1000$ ,  $200$ ,  $50$  and  $20 \text{ mV}$ ).

The maximum voltage would be at the high temperature or highest resistance of the RTD. At  $+40^\circ\text{C}$ , a  $1000 \Omega$  RTD with  $\alpha = 3.75 \Omega/^\circ\text{C}$  is about  $1150 \Omega$ .

Using Ohms law to determine the voltage across the RTD at  $40^\circ\text{C}$ .

$$V = I_X R$$

Using an  $I_X$  value of  $200 \mu\text{A}$ , the voltage is:

$$V = 200 \mu\text{A} \times 1150 \Omega$$

$$V = 230 \text{ mV}$$



This is just over the  $\pm 200$  mV input voltage range of the CR3000. For a maximum voltage of 200 mV, the current  $I_x$  is:

$$I_x = 200 \text{ mV} / 1150 \Omega$$

$$I_x \sim 170 \mu\text{A}$$

### 8.1.2 Reducing Measurement Noise

AC power lines, pumps, and motors can be the source of electrical noise. If the 43347 probe or data logger is located in an electrically noisy environment, the measurement should be made with the 60 or 50 Hz rejection options.

Offsets in the measurement circuitry may be reduced by reversing the current excitation (*RevEx*), and reversing the differential analogue inputs (*RevDiff*), as shown in the program examples in Appendix B.2, *43347-IX Programs (p. B-3)*.

## 9. Troubleshooting and Maintenance

### NOTE

---

All factory repairs and recalibrations require a returned material authorization (RMA) and completion of the “Declaration of Hazardous Material and Decontamination” form. Refer to the *Please Read First* page at the beginning of this manual for more information.

---

### 9.1 Maintenance

Inspect and clean the shield and probe periodically to maintain optimum performance. When the shield becomes coated with a film of dirt, wash it with mild soap and warm water. Use alcohol to remove oil film. Do not use any other solvent. Check mounting bolts periodically for possible loosening due to tower vibration.

### 9.2 Troubleshooting

-99999, NAN displayed in input location:

Make sure the temperature probe is connected to the correct input terminals (see Section 7.5, *Data Logger Programming (p. 17)*). The input terminal refers to the terminal that the black and orange wires are connected to. The white and green wires connect to the next (higher) contiguous terminal.

Unreasonable value displayed in variable:

Make sure the multiplier and offset values for the CRBasic instructions are correct (see Section 7.5, *Data Logger Programming (p. 17)*). For calibrated temperature probes (Section 7.5.4, *Calibration Equation (p. 18)*), make sure the coefficients have been properly scaled and entered. For uncalibrated temperature probes, make sure the multiplier and offset values have been properly entered (Section 7.5.5, *PRTCalc() CRBasic Instruction (p. 19)*).

Temperature reading too high:

Make sure the blower is working properly and there are no obstructions to the air flow in the sensor shield, telescoping arm, or vent holes. Also, check that the probe end of the shield points toward the prevailing wind.

### **9.3 43347 Probe Calibration**

Calibration should be checked every 12 months. Probes used to measure a temperature gradient should be checked with respect to absolute temperature, and with respect to zero temperature difference. An excellent discussion on calibration procedures can be found in the Quality Assurance Handbook for Air Pollution Measurement Systems, Volume IV Meteorological Measurements<sup>1</sup>.

## **10. Attributes and References**

Refer to the RM Young 43502 Instruction Manual for additional information such as replacement parts, assembly drawings, and electrical schematics.

<sup>1</sup>EPA, (1989). *Quality Assurance Handbook for Air Pollution Measurement Systems Volume IV - Meteorological Measurements*, EPA Office of Research and Development, Research Triangle Park, North Carolina 27711.

# Appendix A. Importing Short Cut Code Into CRBasic Editor

---

*Short Cut* creates a .DEF file that contains wiring information and a program file that can be imported into the *CRBasic Editor*. By default, these files reside in the C:\campbellsci\SCWin folder.

Import *Short Cut* program file and wiring information into *CRBasic Editor*:

1. Create the *Short Cut* program following the procedure in Section 4, *QuickStart* (p. 1). After saving the *Short Cut* program, click the **Advanced** tab then the **CRBasic Editor** button. A program file with a generic name will open in CRBasic. Provide a meaningful name and save the CRBasic program. This program can now be edited for additional refinement.

---

## NOTE

Once the file is edited with *CRBasic Editor*, *Short Cut* can no longer be used to edit the program it created.

---

2. To add the *Short Cut* wiring information into the new CRBasic program, open the .DEF file located in the C:\campbellsci\SCWin folder, and copy the wiring information, which is at the beginning of the .DEF file.
3. Go into the CRBasic program and paste the wiring information into it.
4. In the CRBasic program, highlight the wiring information, right-click, and select **Comment Block**. This adds an apostrophe (') to the beginning of each of the highlighted lines, which instructs the data logger compiler to ignore those lines when compiling. The **Comment Block** feature is demonstrated at about 5:10 in the [CRBasic | Features](#) video .



# Appendix B. Example Programs

## B.1 43347-VX Programs

### B.1.1 Example for Calibrated 43347-VX Probes

TABLE B-1 shows the sensor wiring for a CR1000X example program for a calibrated sensor.

TABLE B-1. Wiring for Calibrated 43347-VX Example		
Colour	Function	CR1000X
Clear	Shield	⊥
Red	Switched Excitation	E1
White	Differential High	2H
Green	Differential Low	2L
Black	Differential High	1H
Orange	Differential Low	1L
Purple	Analogue Reference	⊥
43502 Shield		
White	Tachometer	C1
Red	12V Power <sup>1</sup>	
Black	Ground	
<sup>1</sup> Wired to the 115 VAC/12 VDC transformer supplied with the 43502, or separate 12 VDC supply		

Because the calibration coefficients are to convert sensor resistance ( $R_s$ ) to temperature, the **BrHalf4W()** measurement result ( $R_s/R_f$ ) must be multiplied by 1000 ( $R_f$ ), before the coefficients are applied. To do this, the **BrHalf4W** uses *1000* for the *Mult* parameter.

This program includes an instruction to measure and store the tachometer output frequency (Hz) of the 43502 aspirated radiation shield. Storing the output frequency is a way to insure the blower is operational.

**CRBasic Example B-1. CR1000X Example for Calibrated 43347-VX Probes**

```

'CR1000X

'Declare Variables and Units
Public RTD_Res
Public RTD_Cal_C
Units RTD_Cal_C = Deg C
Public Tach_Hz
Units Tach_Hz = Hz

'Define Data Tables
DataTable(Hourly,True,-1)
  DataInterval(0,60,Min,10)
  Average(1,RTD_Cal_C,FP2,False)
  Sample (1,Tach_Hz,FP2)
EndTable

'Main Program
BeginProg
  Scan(5,Sec,1,0)

  'Measure 43347 (calibrated) probe and convert Rs/Rf to Rs
  BrHalf4W(RTD_Res,1,mV200,mV200,1,VX1,1,2000,True,True,0,60,1000,0)

  'Apply calibration coefficients (probe specific)
  '43347 calibration  $T = -250.052585 + (R * 2.375187e-1) + (R^2 * 1.258482e-5)$ 
  RTD_Cal_C = -250.052585 + ((RTD_Res) * 2.375187e-1) + ((RTD_Res^2) * 1.258482e-5)

  'Measure the 43502 tachometer output
  PulseCount (Tach_Hz,1,C1,3,1,1.0,0)

  'Call Data Tables and Store Data
  CallTable(Hourly)
  NextScan
EndProg

```

**B.1.2 Example for Uncalibrated 43347-VX Probes**

TABLE B-2 shows the sensor wiring for a CR1000X example program that measures an uncalibrated probe.

<b>Colour</b>	<b>Function</b>	<b>CR1000X</b>
Clear	Shield	⊥
Red	Switched Excitation	E1
White	Differential High	2H
Green	Differential Low	2L
Black	Differential High	1H
Orange	Differential Low	1L
Purple	Analogue Reference	⊥

**CRBasic Example B-2. CR1000X Example for Uncalibrated 43347-VX Probes**

```

'CR1000X

'Declare Variables
Public RTD_C

'Define Data Tables
DataTable(One_Hour, True, -1)
  DataInterval(0, 15, Min, 0)
  Average(1, RTD_C, FP2, False)
EndTable

'Main Program
BeginProg
  Scan(1, Sec, 1, 0)
  '43347 RTD Temperature Probe (not calibrated) measurement RTD_C:
  BrHalf4W(RTD_C, 1, mV200, mV200, 1, Vx1, 1, 2000, True, True, 0, 60, 1, 0)
  PRTCalc(RTD_C, 1, RTD_C, 5, 1.0, 0.0)
  'Call Data Tables and Store Data
  CallTable(One_Hour)
  NextScan
EndProg

```

## B.2 43347-IX Programs

TABLE B-3 shows the sensor wiring for Appendix B.2.1, *CR3000 Example for Calibrated 43347-IX Probe (p. B-4)*, and Appendix B.2.2, *CR3000 Example for Uncalibrated 43347-IX Probe (p. B-4)*.

These programs include an instruction to measure and store the tachometer output frequency (Hz) of the 43502 aspirated radiation shield. Storing the output frequency is a way to insure the blower is operational.

**TABLE B-3. Wiring for 43347-IX Examples**

Colour	Function	CR6
Red	Switched Current Excitation	U1
White	Differential High	U3
Green	Differential Low	U4
Black	Excitation Return	⊥
Clear	Shield	⊥
<b>43502 Shield</b>		
White	Tachometer	C1
Red	12V power <sup>1</sup>	
Black	Ground <sup>1</sup>	
<sup>1</sup> Wired to the 115 VAC/12 VDC transformer supplied with the 43502, or separate 12 VDC supply		

## B.2.1 Example for Calibrated 43347-IX Probe

This CR6 program measures a calibrated 43347-IX probe every second and stores a 15-minute average temperature in degrees Celsius.

### CRBasic Example B-3. CR6 Example for Calibrated 43347-IX Probe

```
'CR6

'Declare Variables and Units
Public RTD_Res
Public RTD_Cal_C
Public Tach_Hz
Units Tach_Hz = Hz

'Define Data Tables
DataTable(PRT_Data,1,1000)
DataInterval(0,15,Min,1)
Average (1,RTD_Cal_C,IEEE4,False)
Sample (1,Tach_Hz,FP2)
Endtable

'Main Program
BeginProg
Scan(1,Sec,10,0)

'Measure the 43347-IX probe
Resistance (RTD_Res,1,mV200,U3,U1,1,170,True,True,0,60,1,0)

'Convert RTD resistance to temperature
'43347 calibration  $T = -250.052585 + (R * 2.375187e-1) + (R^2 * 1.258482e-5)$ 
RTD_Cal_C = -250.052585 + ((RTD_Res) * 2.375187e-1) + ((RTD_Res^2) * 1.258482e-5)

'Measure the 43502 tachometer output
PulseCount (Tach_Hz,1,C1,3,1,1.0,0)

CallTable PRT_Data

NextScan
EndProg
```

## B.2.2 Example for Uncalibrated 43347-IX Probe

This CR6 program measures an uncalibrated 43347-IX probe every second and stores a 15-minute average temperature in degrees Celsius.

### CRBasic Example B-4. CR6 Example for Uncalibrated 43347-IX Probe

```
'CR6

'Declare Variables and Units
Public RTD_Res
Public RTD_RsRo
Public RTD_C
Public Tach_Hz
Units Tach_Hz = Hz

Const RTD_Ro = 1000.00 'This is the actual RTD resistance for this sensor at 0.0°C

'Define Data Tables
DataTable(PRT_Data,1,1000)
DataInterval(0,15,Min,1)
Average(1,RTD_C,FP2,False)
```



```
Sample (1,Tach_Hz,FP2)
Endtable

'Main Program
BeginProg
Scan(3,Sec,10,0)

'Measure the 43347-IX Probe
Resistance (RTD_Res,1,mV200,U3,U1,1,170,True,True,0,60,1,0)

'Convert RTD resistance to temperature
RTD_RsRo = (RTD_Res / RTD_Ro)
PRTCalc (RTD_C,1,RTD_RsRo,5,1.0,0.0)

'Measure the 43502 tachometer output
PulseCount (Tach_Hz,1,C1,3,1,1.0,0)

CallTable PRT_Data

NextScan
EndProg
```



# Appendix C. 43502 Aspirated Radiation Shield

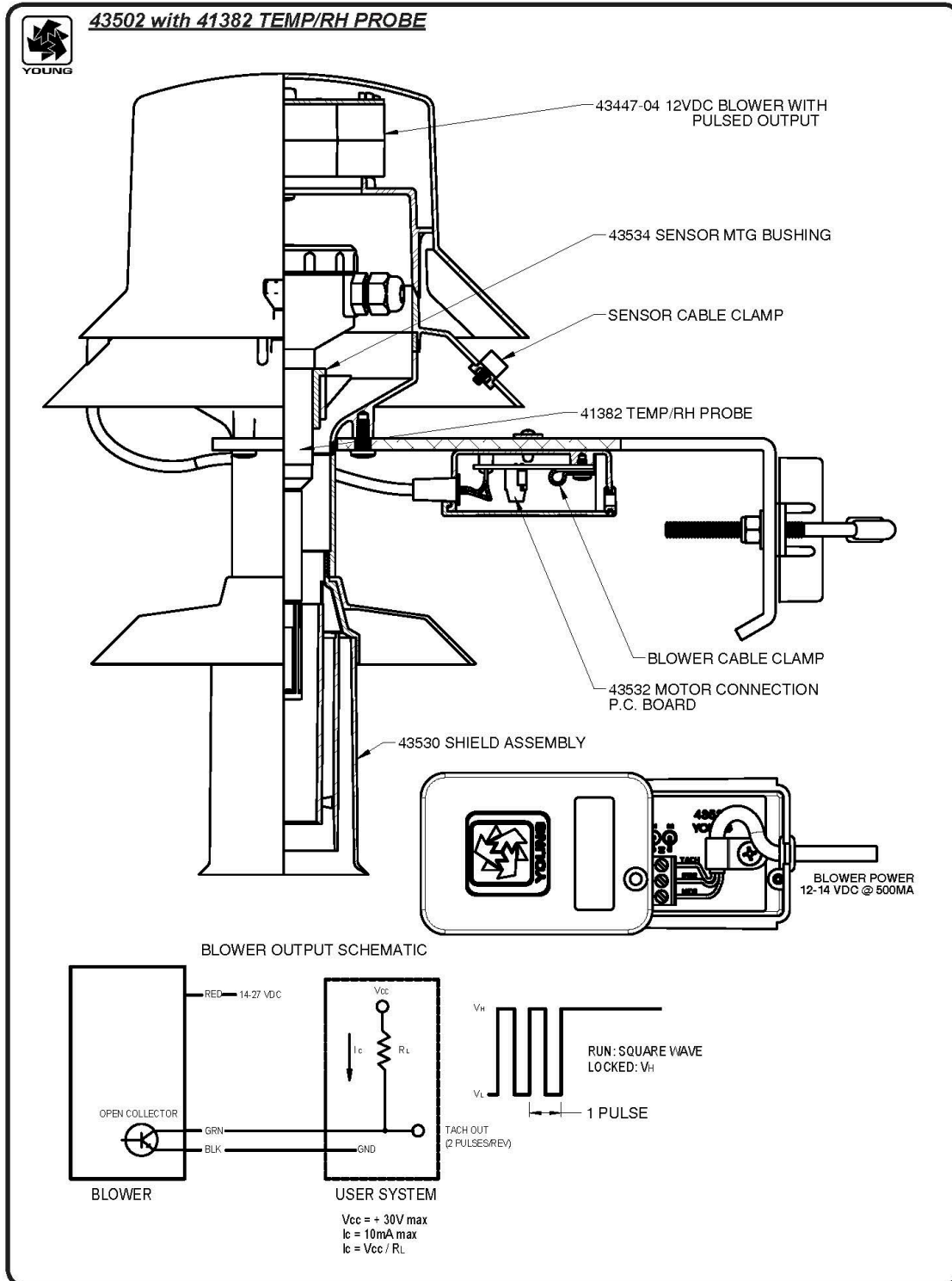

43502-90(E)



# **Appendix D. Measure Multiple 43347-IX Probes Using One Current Excitation Terminal**

---

One current excitation terminal can excite multiple 43347 probes if the “Current Return” wire of the first probe is connected to the “Current Excitation” wire of the second probe.

In theory, a single current excitation terminal can excite up to 25 of the 43347-IX probes with 170  $\mu\text{A}$  if all probes are at a temperature less than or equal to 45 °C. At 45 °C, the 43347 has a resistance of  $\sim 1175 \Omega$ . The resistance increases as more probes are connected in series. The increase of resistance requires the current excitation terminal to raise the driving voltage to maintain the same current. The maximum voltage the current excitation terminal can drive is  $\pm 5 \text{ VDC}$ . Therefore, the maximum number of 43347 probes is:

$$\text{Max. voltage}/(\text{current} \times \text{resistance per probe at } 45 \text{ }^\circ\text{C})$$

$$5 \text{ V}/(0.00017 \text{ A} \times 1175 \Omega) = 25$$

The differential or universal terminal count limits the number of probes to 14 for the CR3000 and 10 for the CR6, unless a multiplexer is used.

One disadvantage to driving multiple probes with a single current excitation terminal is that if one probe shorts or opens then the measurements of all the probes on that terminal will be bad. If, for example, there are two probes at each of three levels, it might be best to drive one probe from each level on one terminal and then drive the remaining probes on another terminal. This creates separate A and B systems, which allow maintenance to be done on one system while the other system continues to make good measurements.

## D.1 Wiring

Wiring for two 43347-IX probes is shown in FIGURE D-1.

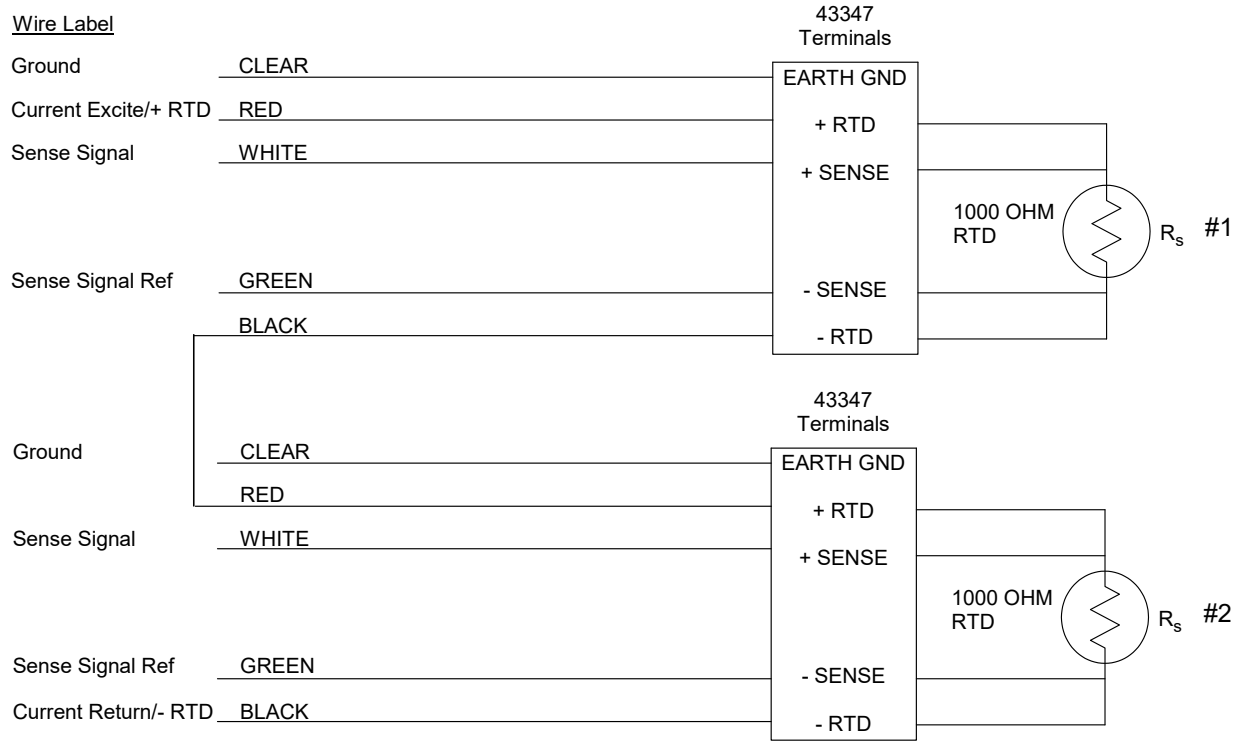

FIGURE D-1. Schematic for two 43347-IX Temperature Probes

## D.2 Example Program for Two Calibrated 43347-IX Probes

This section includes an example CR3000 program that measures two calibrated 43347-IX probes. A CR6 or CR5000 is programmed similarly. Wiring for the example program is shown in TABLE D-1.

TABLE D-1. Wiring for Two 43347-IX Probes Example		
Colour	Function	CR3000
Probe #1		
Red	Switched Current Excitation	IX1
White	Differential High	1H
Green	Differential Low	1L
Black	Excitation Return	Red of Probe #2
Clear	Shield	⊥
Probe #2		
Red	Switched Current Excitation	Black of Probe #1
White	Differential High	2H
Green	Differential Low	2L
Black	Excitation Return	IXR
Clear	Shield	⊥
<b>(2) 43502 Shields</b>		
White	Tachometer	C1 for first probe, C2 for second
Red	12V power <sup>1</sup>	
Black	Ground <sup>1</sup>	
<sup>1</sup> Wired to the 115 VAC/12 VDC transformer supplied with the 43502, or separate 12 VDC supply		

**CRBasic Example D-1. CR3000 Example for Two Calibrated 43347-IX Probes**

```
'CR3000 Series Data Logger
'Declare Variables and Units
Public RTD1_Res, RTD1_Cal_C
Public RTD2_Res, RTD2_Cal_C
Public Tach
Public Tach_1
Units Tach = Hz
Units Tach_1 = Hz

'Define Data Tables
DataTable (PRT_Data,1,1000)
DataInterval (0,15,Min,1)
Average(1,RTD1_Cal_C,IEEE4,False)
```

```
Average(1,RTD2_Cal_C,IEEE4,False)
Sample (1,Tach,FP2)
Sample (1,Tach_1,FP2)
EndTable

'Main Program
BeginProg
Scan (1,Sec,0,0)

    'Measure the 43347-IX probes
    Resistance(RTD1_Res,1,mV200,1,Ix1,1,170,True,True,0,_60Hz,1,0)
    Resistance(RTD2_Res,1,mV200,2,Ix1,1,170,True,True,0,_60Hz,1,0)

    'Convert RTD resistance to temperature
    '43347 #1 calibration  $T = -250.052585 + (R * 2.375187e-1) + (R^2 * 1.258482e-5)$ 
    RTD1_Cal_C = -250.052585 + ((RTD1_Res)*2.375187e-1) + ((RTD1_Res^2)*1.258482e-5)
    '43347 #2 calibration  $T = -250.152585 + (R * 2.475187e-1) + (R^2 * 1.358482e-5)$ 
    RTD2_Cal_C = -250.152585 + ((RTD1_Res)*2.475187e-1) + ((RTD1_Res^2)*1.358482e-5)
    CallTable PRT_Data

'Measure the 43502 tachometer outputs
PulseCount (Tach,1,11,0,1,1.0,0)
PulseCount (Tach_1,1,12,0,1,1.0,0)

NextScan
EndProg
```







# Global Sales & Support Network

*A worldwide network to help meet your needs*



## Australia

*Location:* Garbutt, QLD Australia  
*Phone:* 61.7.4401.7700  
*Email:* [info@campbellsci.com.au](mailto:info@campbellsci.com.au)  
*Website:* [www.campbellsci.com.au](http://www.campbellsci.com.au)

## Brazil

*Location:* São Paulo, SP Brazil  
*Phone:* 11.3732.3399  
*Email:* [vendas@campbellsci.com.br](mailto:vendas@campbellsci.com.br)  
*Website:* [www.campbellsci.com.br](http://www.campbellsci.com.br)

## Canada

*Location:* Edmonton, AB Canada  
*Phone:* 780.454.2505  
*Email:* [dataloggers@campbellsci.ca](mailto:dataloggers@campbellsci.ca)  
*Website:* [www.campbellsci.ca](http://www.campbellsci.ca)

## China

*Location:* Beijing, P. R. China  
*Phone:* 86.10.6561.0080  
*Email:* [info@campbellsci.com.cn](mailto:info@campbellsci.com.cn)  
*Website:* [www.campbellsci.com](http://www.campbellsci.com)

## Costa Rica

*Location:* San Pedro, Costa Rica  
*Phone:* 506.2280.1564  
*Email:* [info@campbellsci.cc](mailto:info@campbellsci.cc)  
*Website:* [www.campbellsci.cc](http://www.campbellsci.cc)

## France

*Location:* Vincennes, France  
*Phone:* 0033.0.1.56.45.15.20  
*Email:* [info@campbellsci.fr](mailto:info@campbellsci.fr)  
*Website:* [www.campbellsci.fr](http://www.campbellsci.fr)

## Germany

*Location:* Bremen, Germany  
*Phone:* 49.0.421.460974.0  
*Email:* [info@campbellsci.de](mailto:info@campbellsci.de)  
*Website:* [www.campbellsci.de](http://www.campbellsci.de)

## India

*Location:* New Delhi, DL India  
*Phone:* 91.11.46500481.482  
*Email:* [info@campbellsci.in](mailto:info@campbellsci.in)  
*Website:* [www.campbellsci.in](http://www.campbellsci.in)

## South Africa

*Location:* Stellenbosch, South Africa  
*Phone:* 27.21.8809960  
*Email:* [sales@campbellsci.co.za](mailto:sales@campbellsci.co.za)  
*Website:* [www.campbellsci.co.za](http://www.campbellsci.co.za)

## Spain

*Location:* Barcelona, Spain  
*Phone:* 34.93.2323938  
*Email:* [info@campbellsci.es](mailto:info@campbellsci.es)  
*Website:* [www.campbellsci.es](http://www.campbellsci.es)

## Thailand

*Location:* Bangkok, Thailand  
*Phone:* 66.2.719.3399  
*Email:* [thitipongc@campbellsci.asia](mailto:thitipongc@campbellsci.asia)  
*Website:* [www.campbellsci.asia](http://www.campbellsci.asia)

## UK

*Location:* Shepshed, Loughborough, UK  
*Phone:* 44.0.1509.601141  
*Email:* [sales@campbellsci.co.uk](mailto:sales@campbellsci.co.uk)  
*Website:* [www.campbellsci.co.uk](http://www.campbellsci.co.uk)

## USA

*Location:* Logan, UT USA  
*Phone:* 435.227.9120  
*Email:* [info@campbellsci.com](mailto:info@campbellsci.com)  
*Website:* [www.campbellsci.com](http://www.campbellsci.com)